

SF40-FR

Shadow Fixed 40mm Fire Rated Rainscreen System

Standard Design Details

DATE:	ISSUE:	CHANGE:

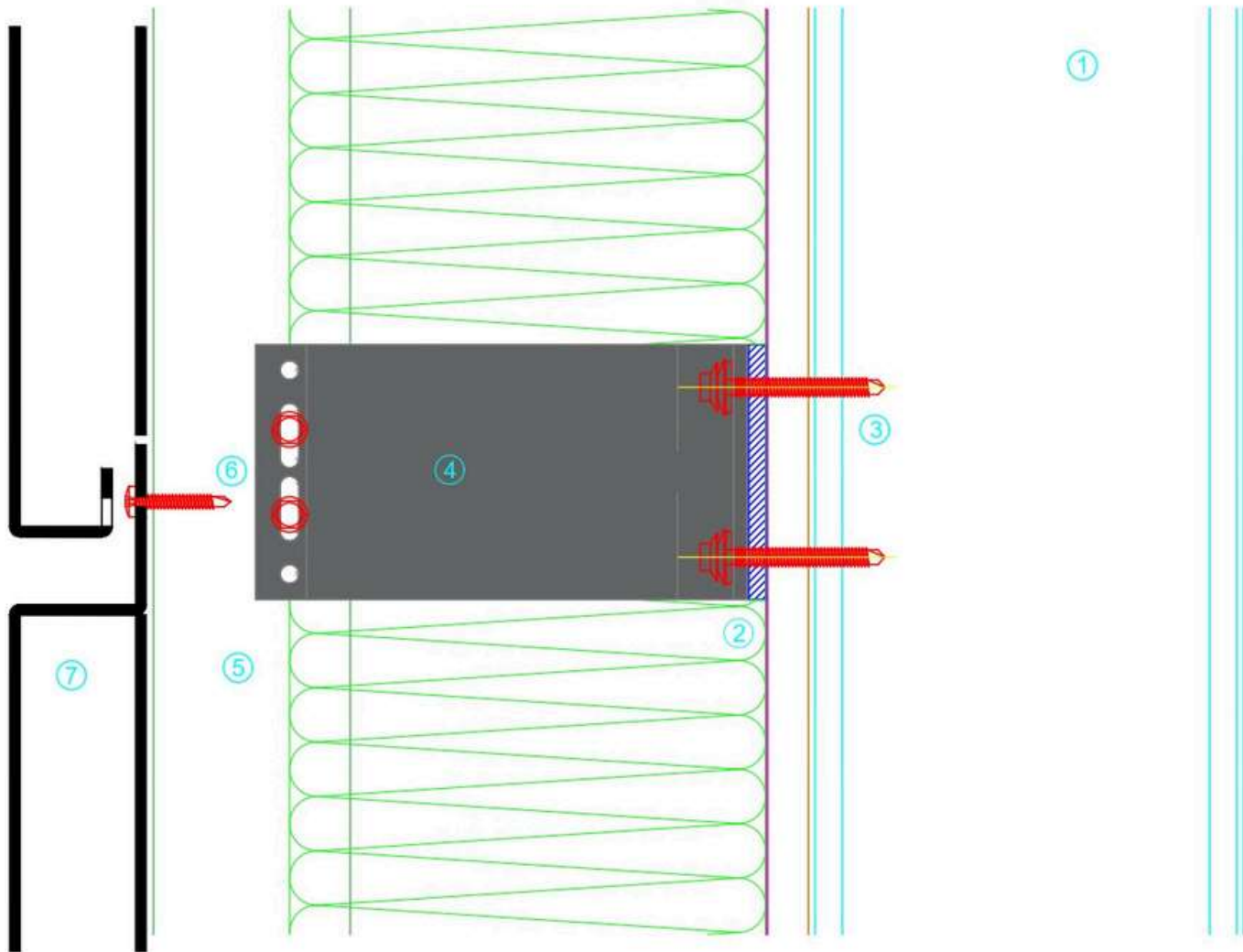

Item	Description
1	Metsec System
2	Insulation (By Others)
3	Wall Fixing (By Others)
4	Wall Bracket
5	Continuous Angle
6	Fixing
7	Rainscreen Panel

SPANWALL

CARRYDUFF BUSINESS PARK, COMBER ROAD, CARRYDUFF, BELFAST, BT8 8AN.

TEL : +44(0)28 9081 5303 FAX : +44(0)28 9081 5449

E-MAIL : Info@spanwall.com

WEBSITE : www.spanwall.com

TITLE :

Horizontal Joint

DRAWING No. :

Standard Details

DRAWN BY :

Justin Reid

SCALE :

1:2

PART No. :

SF40 FR-000

DATE :

25/01/21

APPROVED BY :

AFR

© COPYRIGHT OF THE DESIGNERS.

© DESIGN RIGHTS

DATE:	ISSUE:	CHANGE:

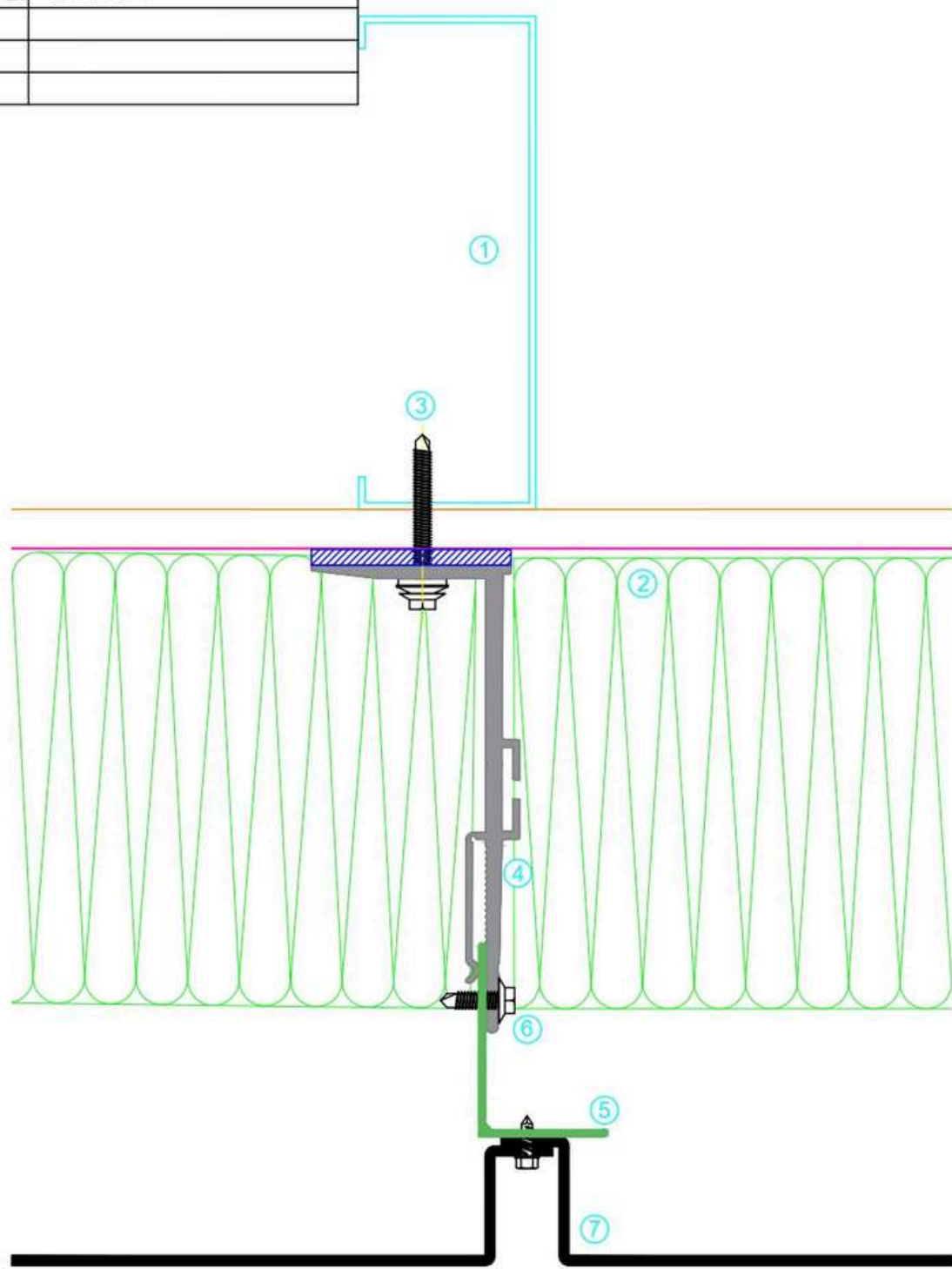

Item	Description
1	Metsec System
2	Insulation (By Others)
3	Wall Fixing (By Others)
4	Wall Bracket
5	Continuous Angle
6	Fixing
7	Rainscreen Panel

SPANWALL

CARRYDUFF BUSINESS PARK, COMBER ROAD, CARRYDUFF, BELFAST, BT8 8AN.
 TEL : +44(0)28 9081 5303 FAX : +44(0)28 9081 5449
 E-MAIL : Info@spanwall.com
 WEBSITE : www.spanwall.com

TITLE :		Vertical Joint	
DRAWING No. :	Standard Details	DRAWN BY :	Justin Reid
PART No. :	SF40 FR-001	DATE :	21/10/2020
		SCALE :	1:2
		APPROVED BY :	AFR
© COPYRIGHT OF THE DESIGNERS.		® DESIGN RIGHTS	

DATE:	ISSUE:	CHANGE:

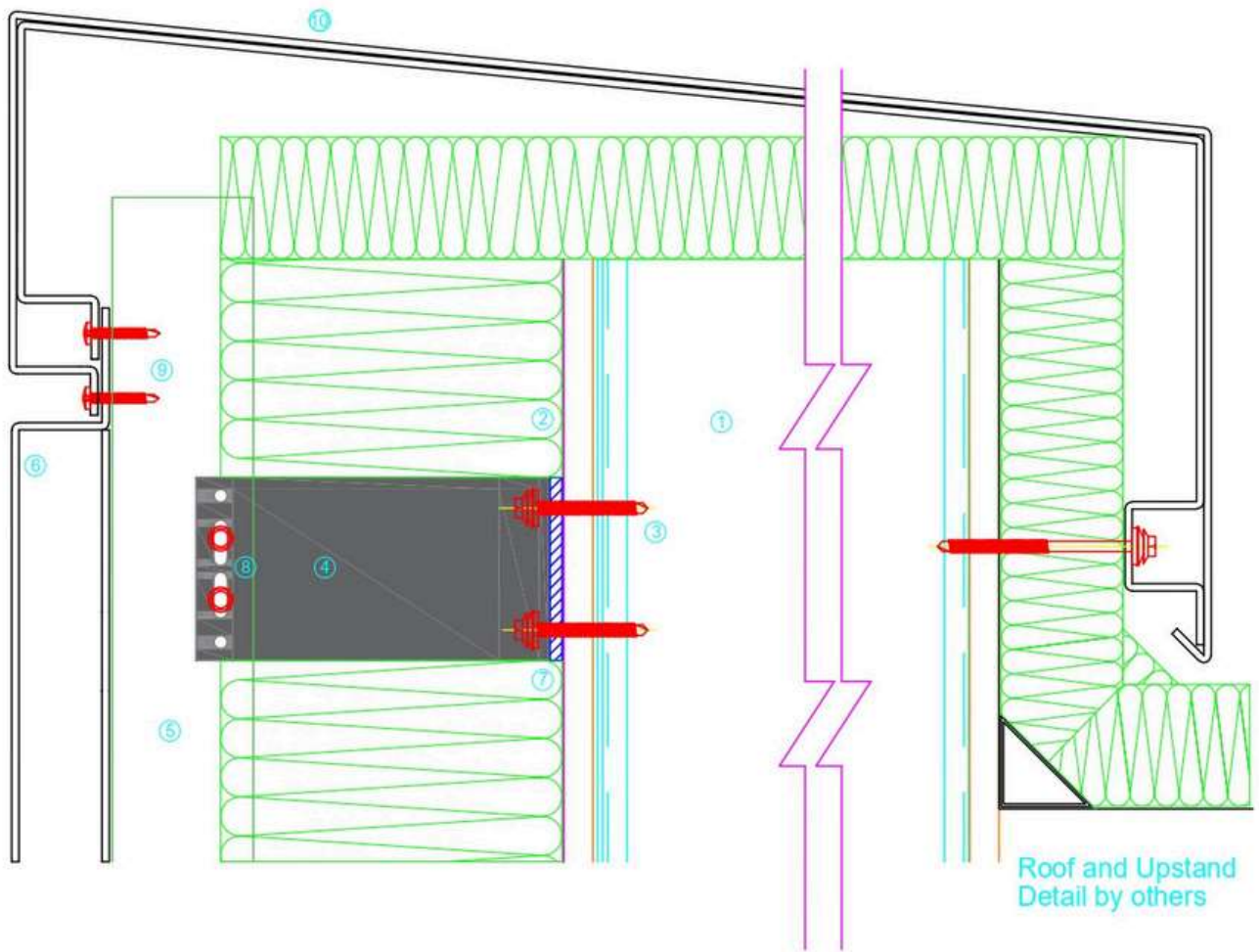

Item	Description
1	Metsec System
2	Insulation (by others)
3	Wall Fixing (by others)
4	Wall Bracket
5	Continuous Angle
6	Rainscreen Panel
7	Thermal Isolator
8	Angle Fixing
9	Panel Fixing
10	Coping Panel

SPANWALL

CARRYDUFF BUSINESS PARK, COMBER ROAD, CARRYDUFF, BELFAST, BT8 8AN.
 TEL : +44(0)28 9081 5303 FAX : +44(0)28 9081 5449
 E-MAIL : Info@spanwall.com
 WEBSITE : www.spanwall.com

TITLE :		Coping Detail	
DRAWING No. :	Standard Details	DRAWN BY :	Andrew Creane
PART No. :	SF40-FR-002	DATE :	21/11/2022
		SCALE :	1:3
		APPROVED BY :	J.Reid
© COPYRIGHT OF THE DESIGNERS.		® DESIGN RIGHTS	

DATE:	ISSUE:	CHANGE:

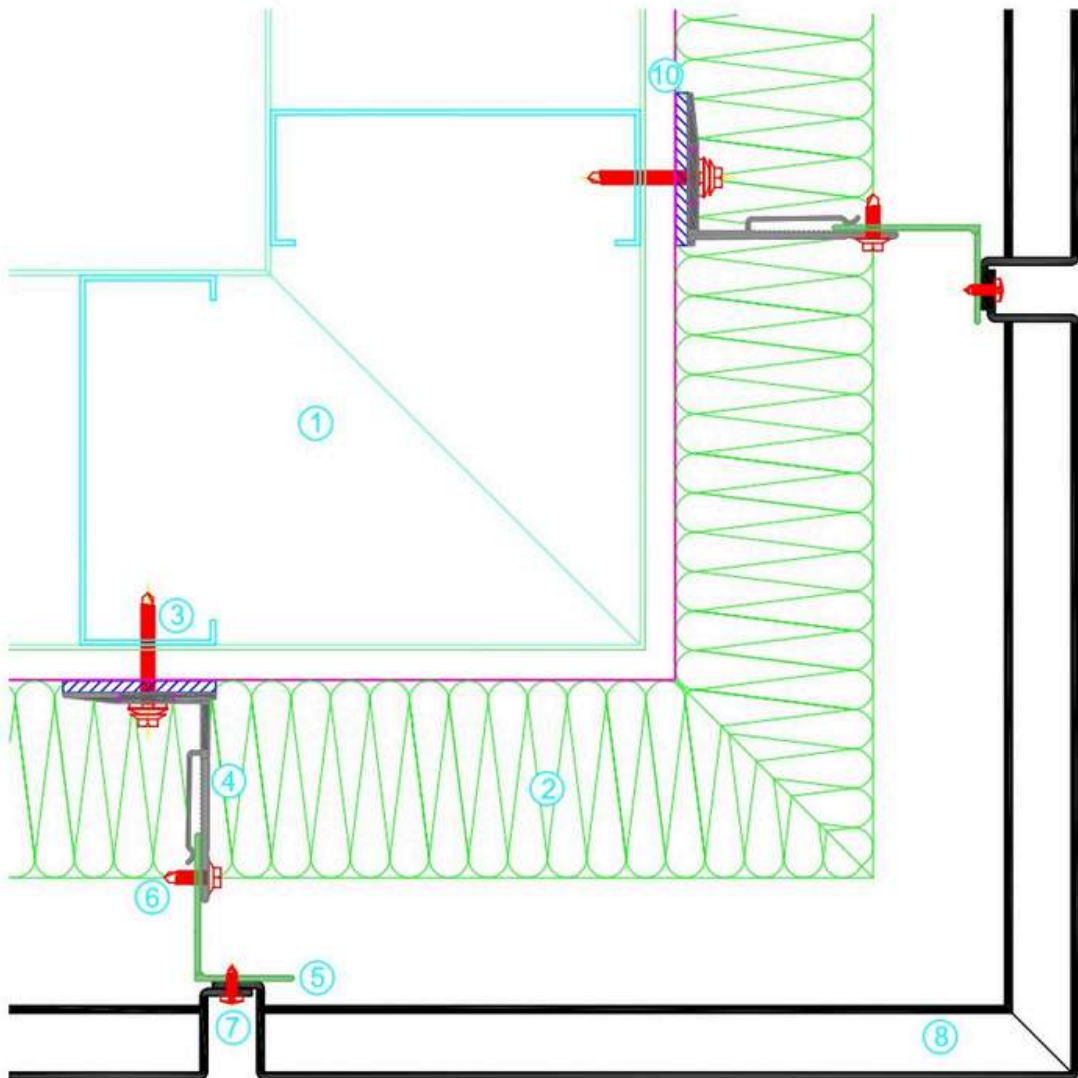

Item	Description
1	Support Wall (by others)
2	Insulation (by others)
3	Wall Fixing (by others)
4	Wall Bracket
5	Continuous Angle
6	Angle Fixing
7	Rainscreen Corner Panel
8	Panel Fixing
9	Thermal Isolator

SPANWALL

CARRYDUFF BUSINESS PARK, COMBER ROAD, CARRYDUFF, BELFAST, BT8 8AN.
 TEL : +44(0)28 9081 5303 FAX : +44(0)28 9081 5449
 E-MAIL : Info@spanwall.com
 WEBSITE : www.spanwall.com

TITLE :		External Corner Detail	
DRAWING No. :	DRAWN BY :	SCALE :	
Standard Details	Andrew Creane	1:3	
PART No. :	DATE :	APPROVED BY :	
SF40-FR-003	21/11/2022	J. Reid	
© COPYRIGHT OF THE DESIGNERS.		® DESIGN RIGHTS	

DATE:	ISSUE:	CHANGE:

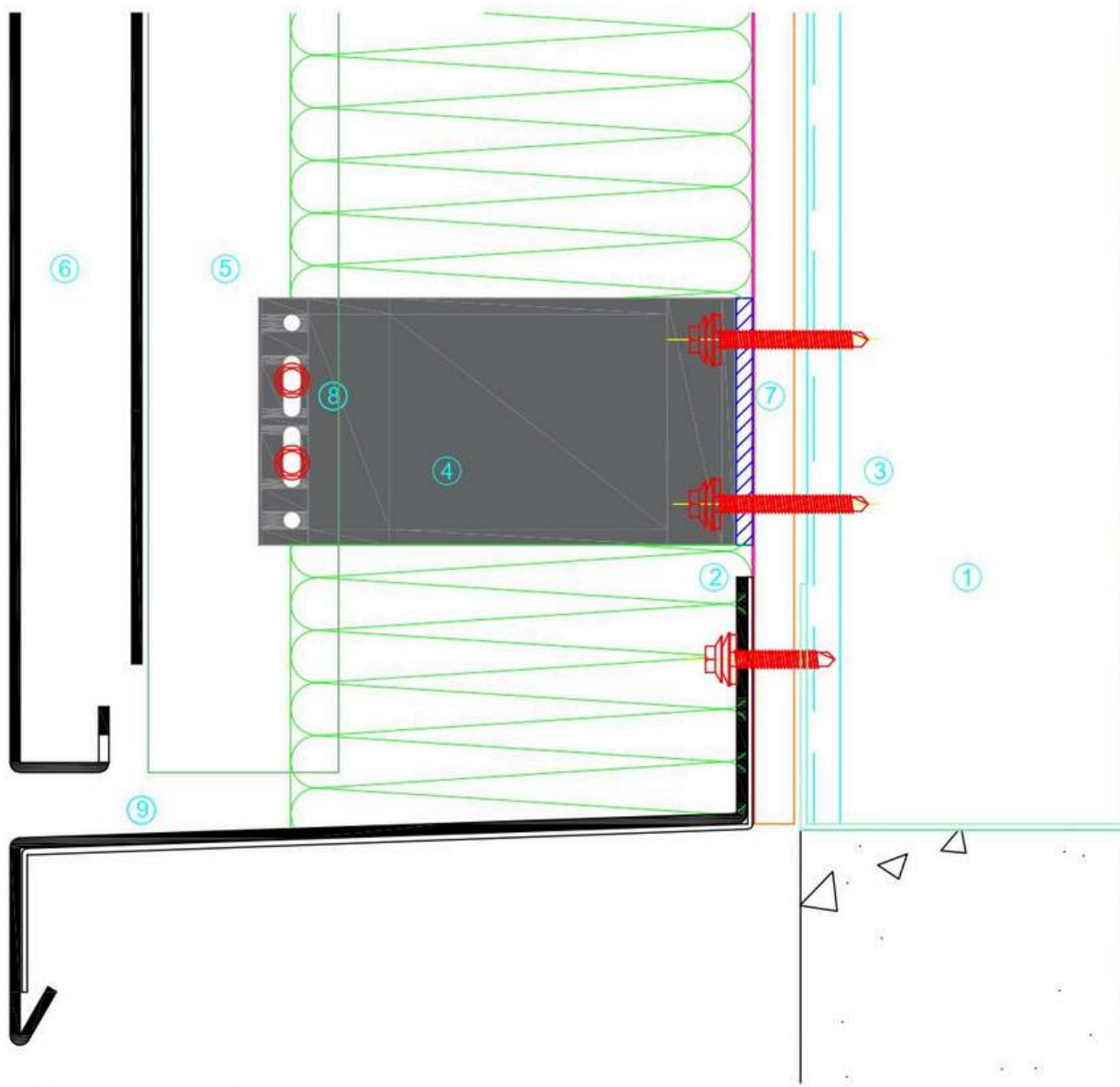

Item	Description
1	Metsec System (by others)
2	Insulation (by others)
3	Wall Fixing (by others)
4	Wall Bracket
5	Continuous Angle
6	Rainscreen Cassette Panel
7	Thermal Isolator
8	Angle Fixing
9	Bottom Cill

SPANWALL

CARRYDUFF BUSINESS PARK, COMBER ROAD, CARRYDUFF, BELFAST, BT8 8AN.
 TEL : +44(0)28 9081 5303 FAX : +44(0)28 9081 5449
 E-MAIL : Info@spanwall.com
 WEBSITE : www.spanwall.com

TITLE :		Bottom Cill	
DRAWING No. :	DRAWN BY :	SCALE :	
Standard Details	Andrew Creane	1:2	
PART No. :	DATE :	APPROVED BY :	
SF40-FR-004	21/11/2022	J. Reid	
© COPYRIGHT OF THE DESIGNERS.		® DESIGN RIGHTS	

DATE:	ISSUE:	CHANGE:

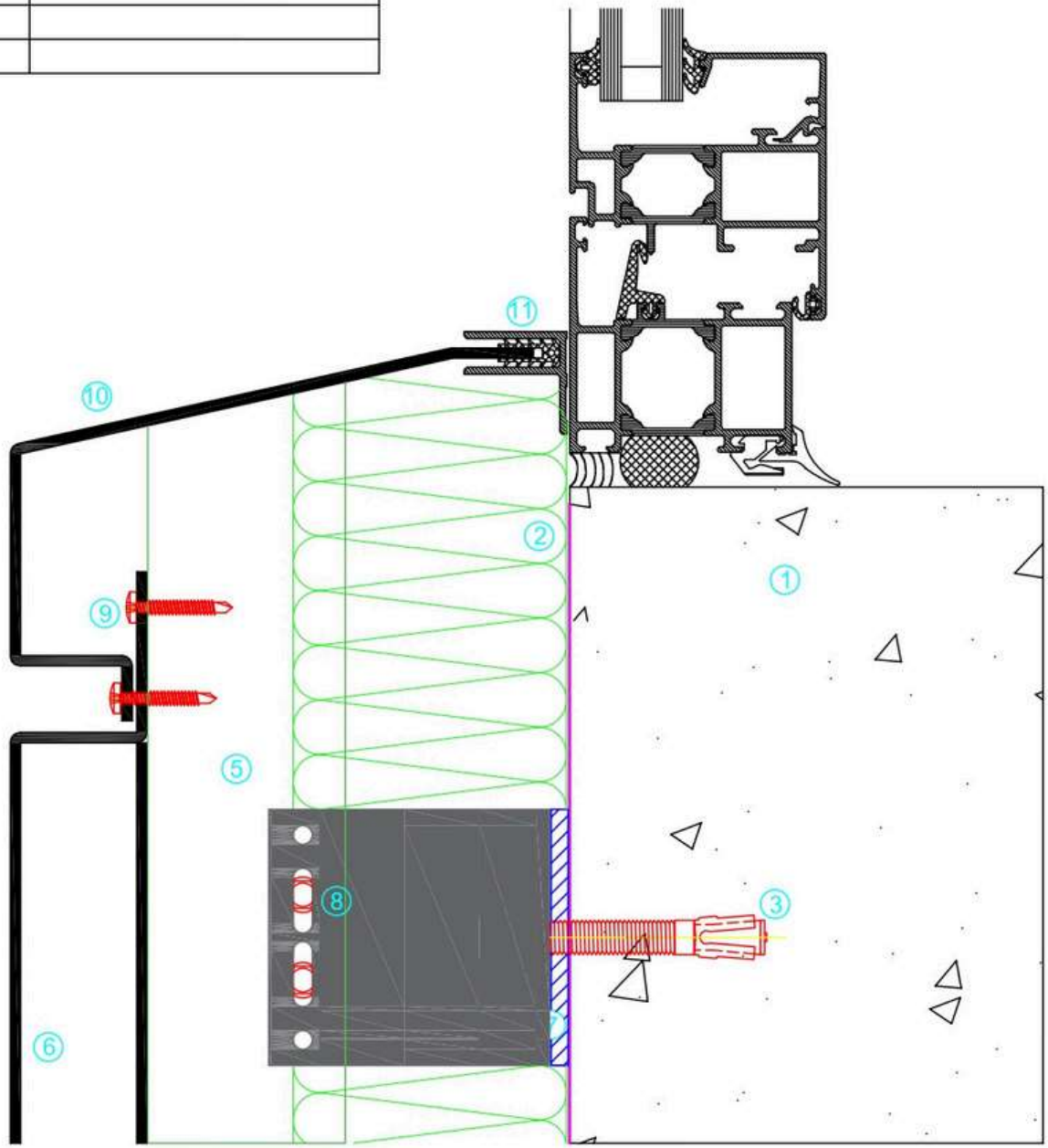

Item	Description
1	Support Wall (by others)
2	Insulation (by others)
3	Wall Fixing (by others)
4	Wall Bracket
5	Continuous Angle
6	Rainscreen Cassette Panel
7	Thermal Isolator
8	Angle Fixing
9	Panel Fixing
10	Cill Flashing
11	F-Section

SPANWALL

CARRYDUFF BUSINESS PARK, COMBER ROAD, CARRYDUFF, BELFAST, BT8 8AN.
 TEL : +44(0)28 9081 5303 FAX : +44(0)28 9081 5449
 E-MAIL : Info@spanwall.com
 WEBSITE : www.spanwall.com

TITLE : **Window Cill**

DRAWING No. : Standard Details	DRAWN BY : Andrew Creane	SCALE : 1:2
PART No. : SF40-FR-005	DATE : 21/11/22	APPROVED BY : J. Reid

DATE:	ISSUE:	CHANGE:

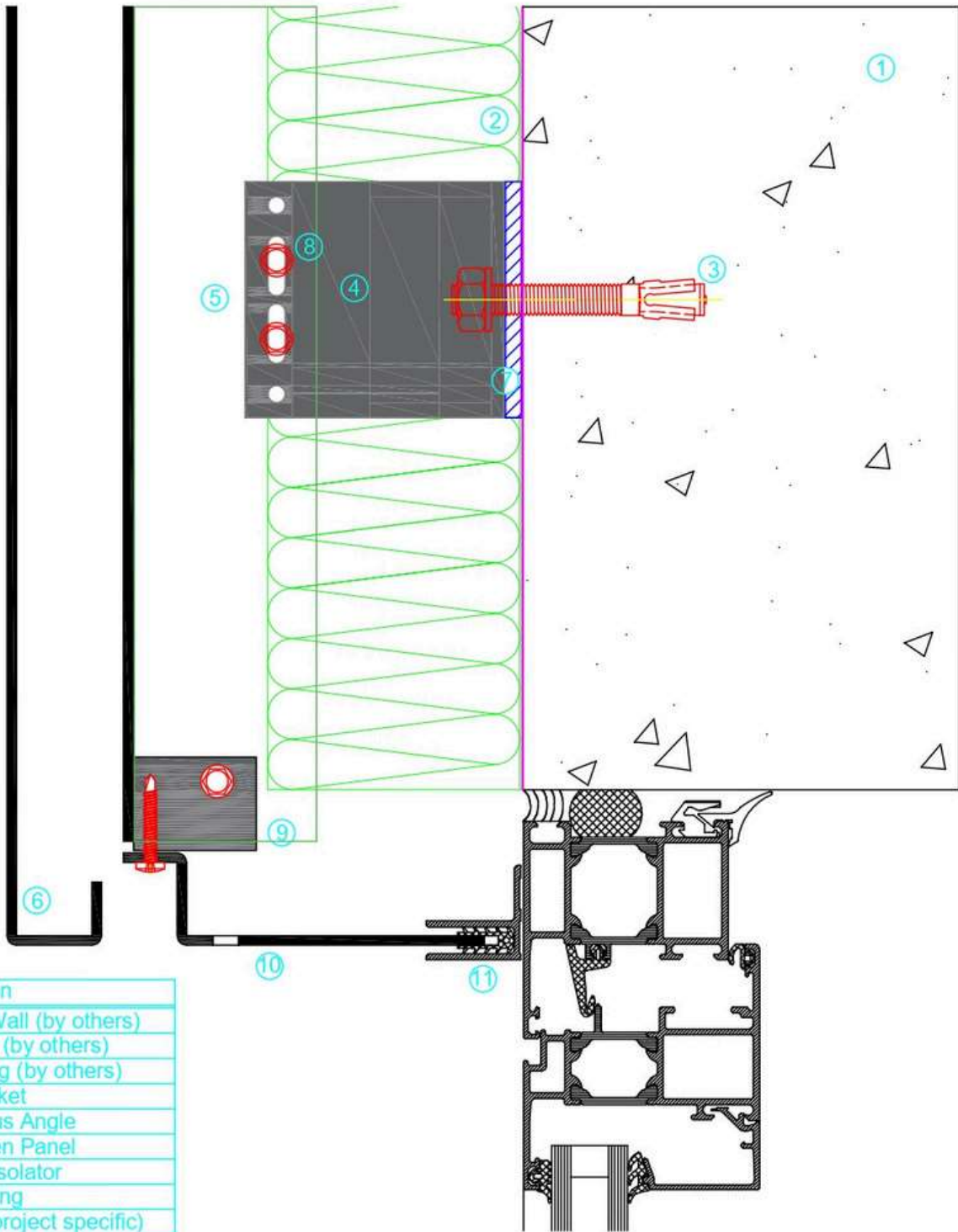

Item	Description
1	Support Wall (by others)
2	Insulation (by others)
3	Wall Fixing (by others)
4	Wall Bracket
5	Continuous Angle
6	Rainscreen Panel
7	Thermal Isolator
8	Angle Fixing
9	Bracket (project specific)
10	Head Flashing
11	F-Section

SPANWALL

CARRYDUFF BUSINESS PARK, COMBER ROAD, CARRYDUFF, BELFAST, BT8 8AN.
 TEL : +44(0)28 9081 5303 FAX : +44(0)28 9081 5449
 E-MAIL : Info@spanwall.com
 WEBSITE : www.spanwall.com

TITLE :		Window Head	
DRAWING No. :	DRAWN BY :	SCALE :	
Standard Details	Andrew Creane	1:2	
PART No. :	DATE :	APPROVED BY :	
SF40-FR-006	21/11/2022	J. Reid	
© COPYRIGHT OF THE DESIGNERS.		® DESIGN RIGHTS	

DATE:	ISSUE:	CHANGE:

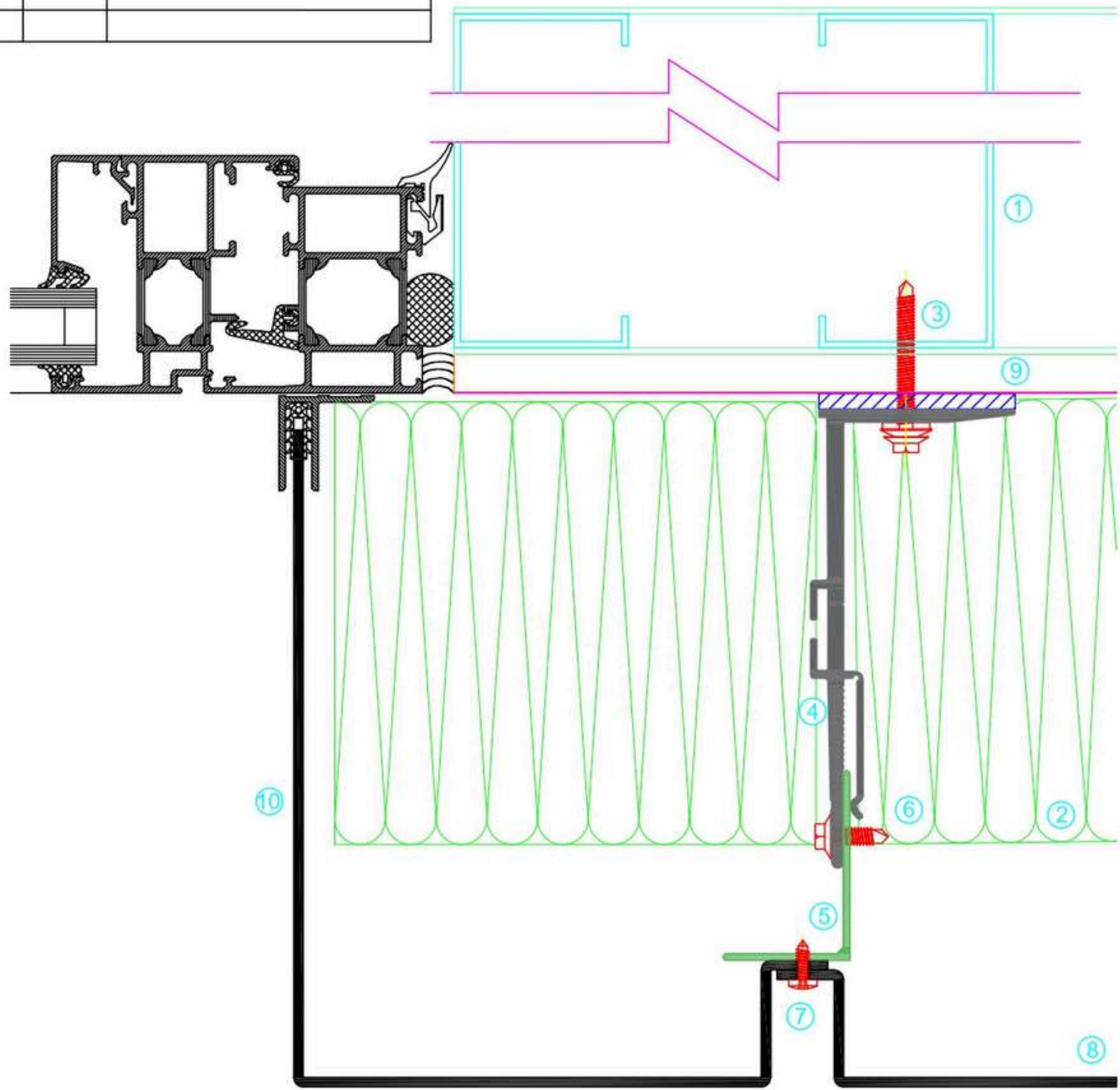

Item	Description
1	Metsec System (by others)
2	Insulation (by others)
3	Wall Fixing (by others)
4	Wall Bracket
5	Continuous Angle
6	Angle Fixing
7	Panel Fixing
8	Rainscreen Panel
9	Thermal Isolator
10	Jamb Flashing

SPANWALL

CARRYDUFF BUSINESS PARK, COMBER ROAD, CARRYDUFF, BELFAST, BT8 8AN.
 TEL : +44(0)28 9081 5303 FAX : +44(0)28 9081 5449
 E-MAIL : Info@spanwall.com
 WEBSITE : www.spanwall.com

TITLE :		Window Jamb	
DRAWING No. :	Standard Details	DRAWN BY :	Andrew Creane
PART No. :	SF40-FR-007	DATE :	21/11/2022
© COPYRIGHT OF THE DESIGNERS.		SCALE : 1:2	
		APPROVED BY : J. Reid	
		® DESIGN RIGHTS	

DATE:	ISSUE:	CHANGE:

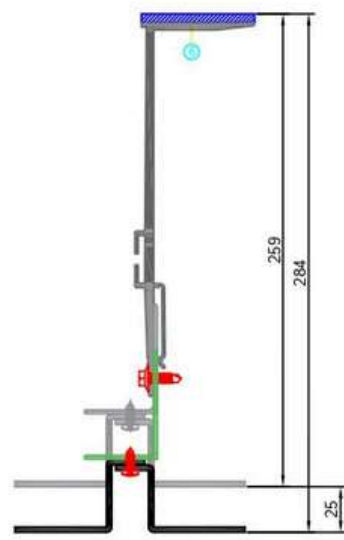
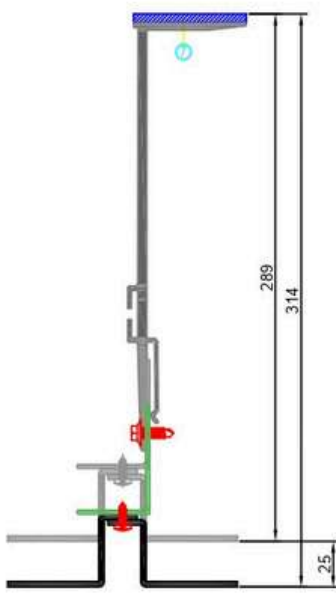
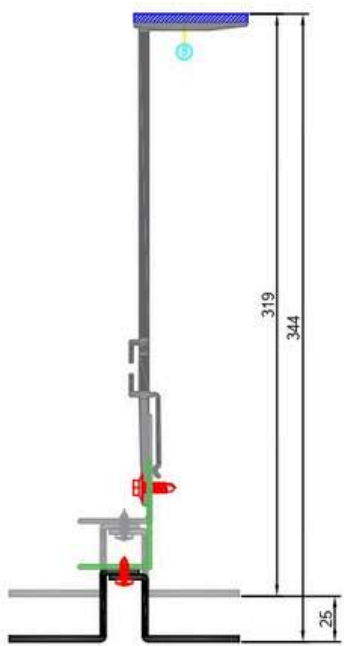
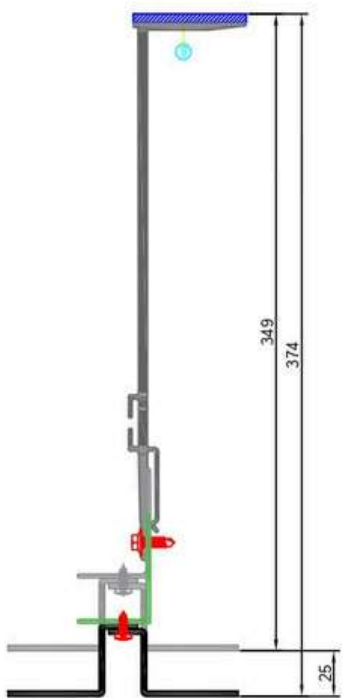
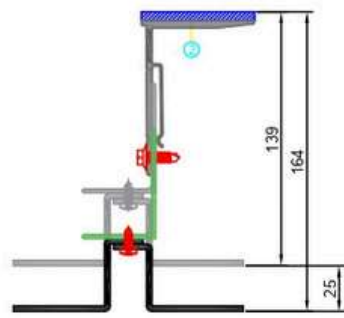
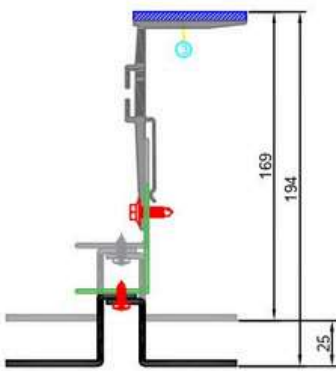
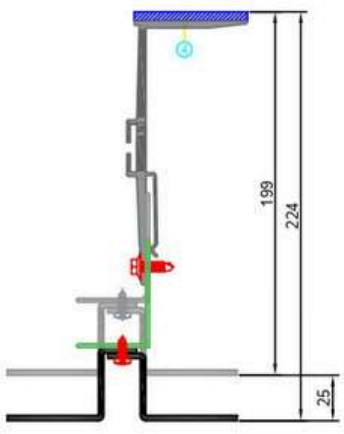
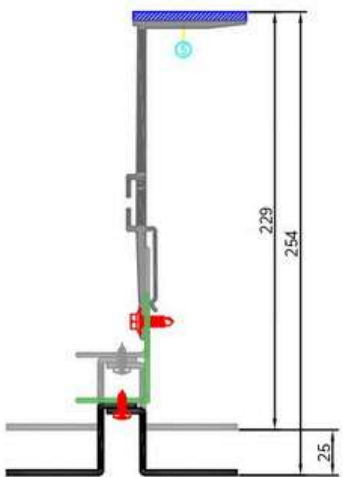
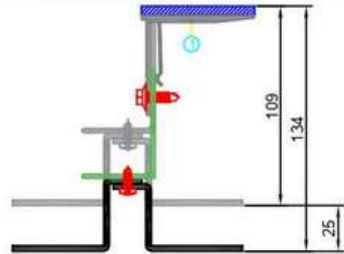
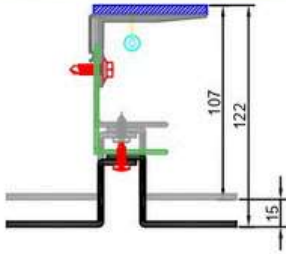

Item	Description	Cladding Zone Range
00	Wall Bracket 40	107 - 122mm
01	Wall Bracket 65	139 - 164mm
02	Wall Bracket 90	169 - 194mm
03	Wall Bracket 120	199 - 224mm
04	Wall Bracket 150	229 - 254mm
05	Wall Bracket 180	259 - 284mm
06	Wall Bracket 210	289 - 314mm
07	Wall Bracket 240	319 - 344mm
08	Wall Bracket 270	349 - 374mm
09	Wall Bracket 300	374 - 399mm

SPANWALL

CARRYDUFF BUSINESS PARK, COMBER ROAD, CARRYDUFF, BELFAST, BT8 8AN.
 TEL : +44(0)28 9081 5303 FAX : +44(0)28 9081 5449
 E-MAIL : Info@spanwall.com
 WEBSITE : www.spanwall.com

TITLE :

Cladding Zone Variations

DRAWING No. :
Standard Details
 PART No. :
SF40-FR-008

DRAWN BY :
Andrew Creane
 DATE :
21/11/2022

SCALE :
NTS
 APPROVED BY :
J. Reid



Talk to us today...

Main Office

**Unit 1, Carryduff Park, Comber Road,
Carryduff, Belfast BT8 8AN Northern Ireland**

T: +44 (0)28 9081 5303

E: info@spanwall.com

Head of Commercial - Gabe McArdle

T: +44 (0)79 6655 2116

E: gmcardle@spanwall.com

Business Development Manager GB North - Rinoj Raju

T: +44 (0)78 4241 4938

E: rāju@spanwall.com

www.spanwall.com

